

IMAGE



XLT
SmartSolutions™

MODEL

3250-DS H-version

SIZE

**32" WIDE CONVEYOR
50" LONG BAKE CHAMBER**

TYPE

GAS

TOP VIEW

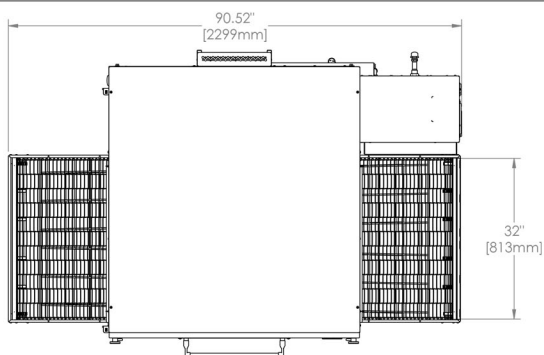

FRONT VIEWS

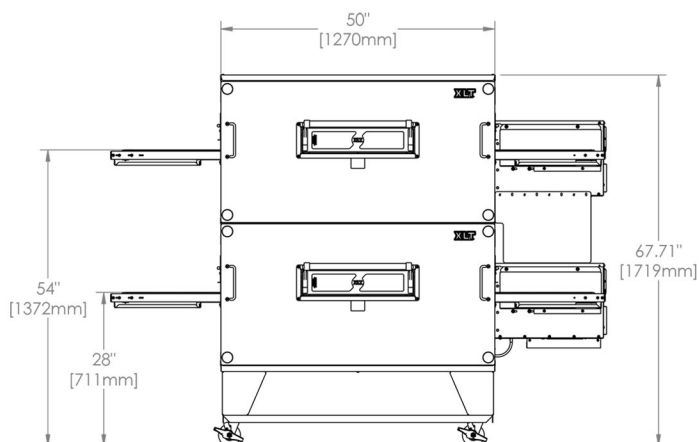
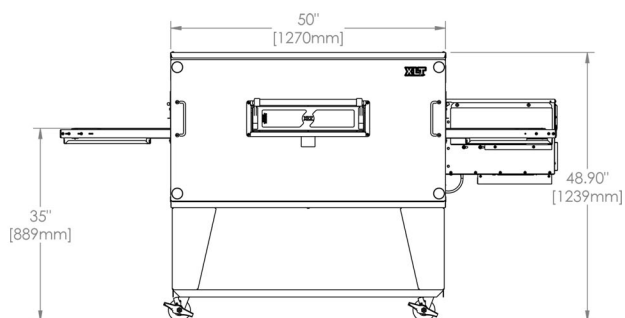

SIDE VIEWS

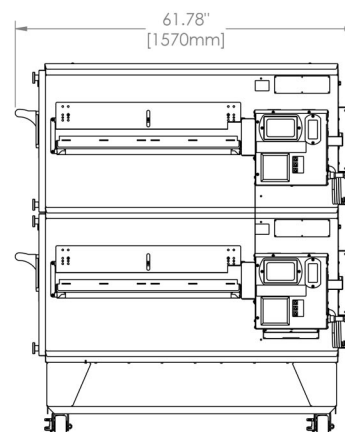
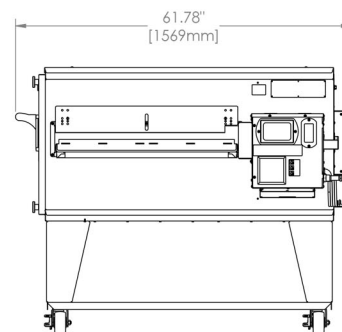

3250-DS H-version

DATA SHEET

3250H-DS GAS OVEN

Heating Value

Standard	World		
	Natural	Propane	Butane
140,000 BTU/Hr	41.03 Kw/Hr	41.03 Kw/Hr	44.54 Kw/Hr
	147.71 Mj/Hr	147.71 Mj/Hr	

Electrical Requirement

Standard	World
120 VAC, 4.8 Amps, 50/60 Hz	220/230/240 VAC Option, 3 Amps, 50/60 Hz

Inlet Pressure Range

	W/C	mbar	kPa	kPa (Korea)
Natural Gas	6-14	15-35	1.50 - 3.50	1.50 - 2.50
Propane Gas	11 - 14	27.5 - 35	2.75 - 3.50	2.30 - 3.30

Manifold Pressure Range

	W/C	mbar	kPa
Natural Gas	3.5	8.75	0.875
Propane Gas	10	25	2.50

Oven Weight

	Single (1 crate)		Double (2 crates)	
	lbs	kg	lbs	kg
Oven Only	978	444	1779	807

OVEN WARRANTY

USA & Canada (Parts & Labor)	International (Parts & Labor)
7 Years Standard	5 Years Standard

