



MODEL

**3870**

H-version

SIZE

**38" WIDE CONVEYOR  
70" LONG BAKE CHAMBER**

TYPE

**GAS**

TOP VIEW

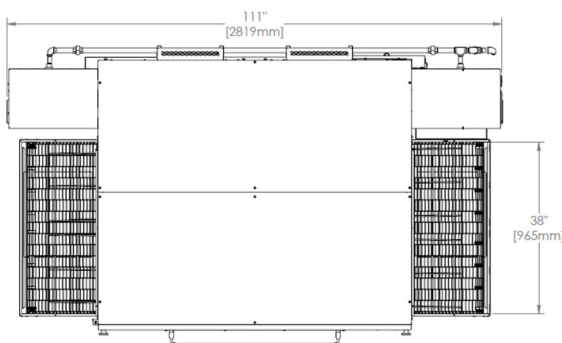

FRONT VIEWS

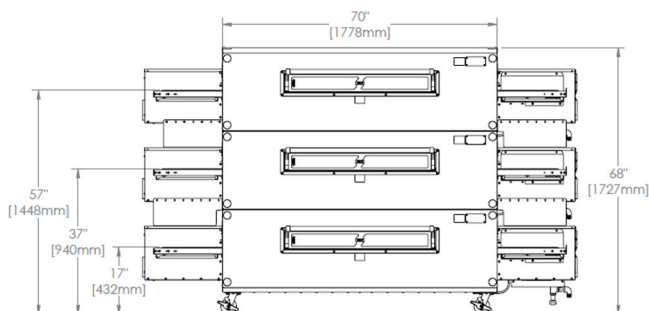
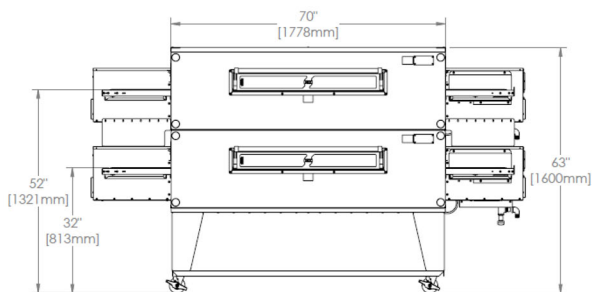
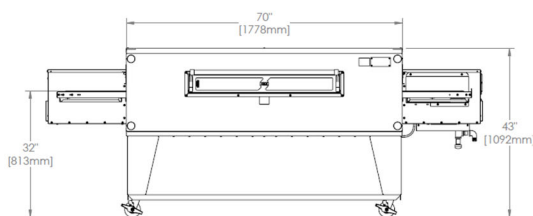

SIDE VIEWS

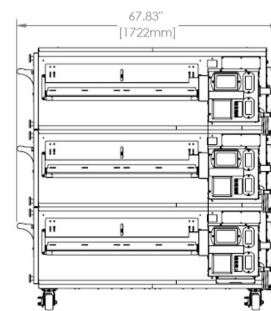
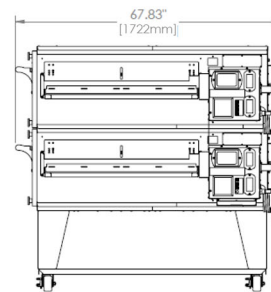
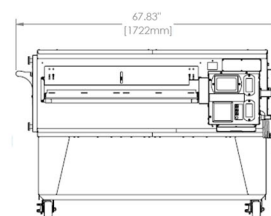

# 3870

MODEL

H-version

# XLT

SmartSolutions™

## DATA SHEET 3870H GAS OVEN

### Heating Value

Standard	World		
	Natural	Propane	Butane
209,000 BTU/Hr	61.25 Kw/Hr	61.25 Kw/Hr	65.94 Kw/Hr
	220.51 Mj/Hr	220.51 Mj/Hr	

### Electrical Requirement

Standard	World
120 VAC, 8.5 Amps, 50/60 Hz	220/230/240 VAC Option, 7 Amps, 50/60 Hz

### Inlet Pressure Range

	W/C	mbar	kPa	kPa (Korea)
Natural Gas	6-14	15-35	1.50 - 3.50	1.50 - 2.50
Propane Gas	11 - 14	27.5 - 35	2.75 - 3.50	2.30 - 3.30

### Manifold Pressure Range

	W/C	mbar	kPa
Natural Gas	3.5	8.75	0.875
Propane Gas	10	25	2.50

### Oven Weight

	Single (1 crate)		Double (2 crates)		Triple (3 crates)	
	lbs	kg	lbs	kg	lbs	kg
Oven Only	1369	621	2534	1149	3801	1724

## OVEN & HOOD WARRANTY

USA & Canada (Parts & Labor)	International (Parts & Labor)
<b>10</b> Years   Oven & Hood Combo Purchase*	<b>7</b> Years   Oven & Hood Combo Purchase
7 Years   Standard	5 Years   Standard

\*Pre-piped ANSUL system must be purchased on each oven and hood

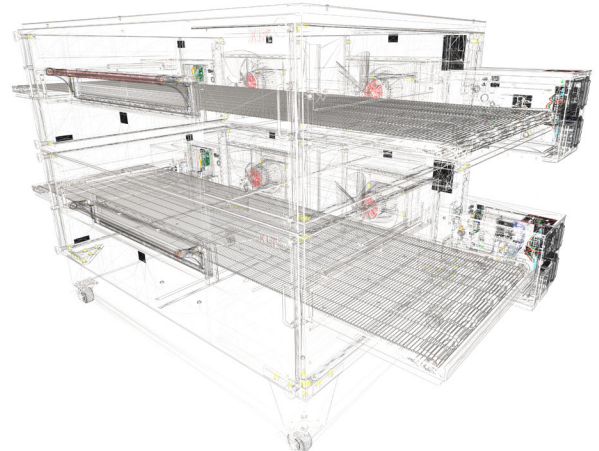
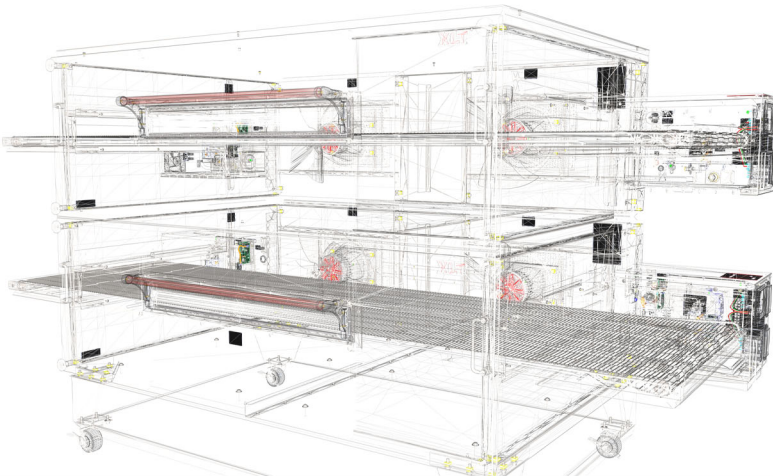

(316) 943-2751  
 SALES@XLTOVENS.COM  
 SERVICE@XLTOVENS.COM

WWW.XLTOVENS.COM  
 24/7/365 LIVE TECHNICAL SUPPORT

